

**Industrial Communication Platform**

**Lanner**

**LEC-3030 Series**

**Industrial Communication Platform**

**User Manual**

Rev 1.1

Date: December 27<sup>th</sup>, 2016

## Industrial Communication Platform

### Revision History

Revision	Date	Description
0.1	January 28, 2016	Preliminary
1.0	April 26, 2016	Official release
1.1	December 27, 2016	Including LEC-3030A & LEC-3030T

This document contains proprietary information of Lanner Electronics Inc. –and is not to be disclosed or used except in accordance with applicable agreements.

**Copyright © 2016. All Rights Reserved.**

Copyright© 2016 Lanner Electronics Inc. All rights reserved. The information in this document is proprietary and confidential to Lanner Electronics Inc. No part of this document may be reproduced in any form or by any means or used to make any derivative work (such as translation, transformation, or adaptation) without the express written consent of Lanner Electronics Inc. Lanner Electronics Inc. reserves the right to revise this document and to make changes in content from time to time without obligation on the part of Lanner Electronics Inc. to provide notification of such revision or change.

The information in this document is furnished for informational use only, is subject to change without notice, and should not be construed as a commitment by Lanner Electronics Inc. Lanner Electronics Inc. assumes no responsibility or liability for any errors or inaccuracies that may appear in this document or any software that may be provided in association with this document.

### Online Resources

The listed websites are links to the on-line product information and technical support.

Resource	Website
Lanner	<a href="http://www.lannerinc.com">www.lannerinc.com</a>
Product Resources	<a href="http://www.lannerinc.com/support/download-center">www.lannerinc.com/support/download-center</a>
RMA	<a href="http://eRMA.lannerinc.com">http://eRMA.lannerinc.com</a>

### Acknowledgement

Intel®, Pentium and Celeron are registered trademarks of Intel® Corp.

Microsoft Windows and MS-DOS are registered trademarks of Microsoft Corp.

All other product names or trademarks are properties of their respective owners.

### Compliances and Certification

#### CE Certification

This product has passed the CE test for environmental specifications. Test conditions for passing included the equipment being operated within an industrial enclosure. In order to protect the product from being damaged by ESD (Electrostatic Discharge) and EMI leakage, we strongly recommend the use of CE-compliant industrial enclosure products.

#### FCC Class A Certification

This equipment has been tested and found to comply with the limits for a Class A digital device, pursuant to Part 15 of the FCC Rules. These limits are designed to provide reasonable protection against harmful interference when the equipment is operated in a commercial environment. This equipment generates, uses and can radiate radio frequency energy and, if not installed and used in accordance with the instruction manual, may cause harmful interference to radio communications. Operation of this equipment in a residential area is likely to cause harmful interference in which case the user will be required to correct the interference at his own expense.

#### EMC Notice

This equipment has been tested and found to comply with the limits for a Class A digital device, pursuant to Part 15 of the FCC Rules. These limits are designed to provide reasonable protection against harmful interference when the equipment is operated in a commercial environment. This equipment generates, uses, and can radiate radio frequency energy and, if not installed and used in accordance with the instruction manual, may cause harmful interference to radio communications. Operation of this equipment in a residential area is likely to cause harmful

## Industrial Communication Platform

interference in which case users will be required to correct the interference at their own expense.

### Safety Guidelines

- Follow these guidelines to ensure general safety:
- Keep the chassis area clear and dust-free before, during and after installation.
- Do not wear loose clothing or jewelry that could get caught in the chassis. Fasten your tie or scarf and roll up your sleeves.
- Wear safety glasses/goggles if you are working under any conditions that might be hazardous to your eyes.
- Do not perform any action that creates a potential hazard to people or makes the equipment unsafe.
- Disconnect all power by turning off the power and unplugging the power cord before installing or removing a chassis or working near power supplies
- Do not work alone if potentially hazardous conditions exist.
- Never assume that power is disconnected from a circuit; always check the circuit.

### LITHIUM BATTERY CAUTION:

Risk of explosion could occur if battery is replaced by an incorrect type. Please dispose of used batteries according to the recycling instructions of your country.

- Installation only by a trained electrician or only by an electrically trained person who knows all the applied or related installation and device specifications..
- Do not carry the handle of power supplies when moving to other place.
- The machine can only be used in a fixed location such as labs or computer facilities.

### Operating Safety

- Electrical equipment generates heat. Ambient air temperature may not be adequate to cool equipment to acceptable operating temperatures without adequate circulation. Be sure that the room in which you choose to operate your system has adequate air circulation.
- Ensure that the chassis cover is secure. The chassis design allows cooling air to circulate effectively. An open chassis permits air leaks, which may interrupt and redirect the flow of cooling air from internal components.

Electrostatic discharge (ESD) can damage equipment and impair electrical circuitry. ESD damage occurs when electronic components are improperly handled and can result in complete or intermittent failures. Be sure to follow ESD-prevention procedures when removing and replacing components to avoid these problems.

- Wear an ESD-preventive wrist strap, ensuring that it makes good skin contact. If no wrist strap is available, ground yourself by touching the metal part of the chassis.

## Industrial Communication Platform

- Periodically check the resistance value of the antistatic strap, which should be between 1 and 10 mega ohms (Mohms).

### Mounting Installation Environment Precaution

1. Elevated Operating Ambient - If installed in a closed or multi-unit rack assembly, the operating ambient temperature of the rack environment may be greater than room ambient. Therefore, consideration should be given to installing the equipment in an environment compatible with the maximum ambient temperature (T<sub>ma</sub>) specified by the manufacturer.
2. Reduced Air Flow - Installation of the equipment in a rack should be such that the amount of air flow required for safe operation of the equipment is not compromised.
3. Mechanical Loading - Mounting of the equipment in the rack should be such that a hazardous condition is not achieved due to uneven mechanical loading.
4. Circuit Overloading - Consideration should be given to the connection of the equipment to the supply circuit and the effect that overloading of the circuits might have on over-current protection and supply wiring. Appropriate consideration of equipment nameplate ratings should be used when addressing this concern.
5. Reliable Earthing - Reliable earthing of rack-mounted equipment should be maintained. Particular attention should be given to supply connections other than direct connections to the branch circuit (e.g. use of power strips)."

### Consignes de sécurité

Suivez ces consignes pour assurer la securite generale :

- Laissez la zone du chassis propre et sans poussiere pendant et apres l'installation.
- Ne portez pas de vetements amples ou de bijoux qui pourraient etre pris dans le chassis. Attachez votre cravate ou echarpe et remontez vos manches.
- Portez des lunettes de securite pour proteger vosmyeux.
- N'effectuez aucune action qui pourrait creer un dangermpour d'autres ou rendre l'equipement dangereux.
- Coupez completement l'alimentation en eteignant l'alimentation et en debranchant le cordon d'alimentation avant d'installer ou de retirer un chassis ou de travailler a proximite de sources d'alimentation.
- Ne travaillez pas seul si des conditions dangereuses sont presentes.
- Ne considerez jamais que l'alimentation est coupee d'un circuit, verifiez toujours le circuit. Cet appareil genere, utilise et emet une energie radiofrequence et, s'il n'est pas installe et utilise conformement aux instructions des fournisseurs de composants sans fil, il risque de provoquer des interferences dans les communications radio.

### **Avertissement concernant la pile au lithium**

- Risque d'explosion si la pile est remplacée par une autre d'un mauvais type.
- Jetez les piles usagées conformément aux instructions.
- L'installation doit être effectuée par un électricien formé ou une personne formée à l'électricité connaissant toutes les spécifications d'installation et d'appareil du produit.
- Ne transportez pas l'unité en la tenant par le câble d'alimentation lorsque vous déplacez l'appareil.
- La machine ne peut être utilisée qu'à un lieu fixe comme en laboratoire, salle d'ordinateurs ou salle de classe.

### **Sécurité de fonctionnement**

- L'équipement électrique génère de la chaleur. La température ambiante peut ne pas être adéquate pour refroidir l'équipement à une température de fonctionnement acceptable sans circulation adaptée. Vérifiez que votre site propose une circulation d'air adéquate.
  - Vérifiez que le couvercle du châssis est bien fixé. La conception du châssis permet à l'air de refroidissement de bien circuler. Un châssis ouvert laisse l'air s'échapper, ce qui peut interrompre et rediriger le flux d'air frais destiné aux composants internes.
  - Les décharges électrostatiques (ESD) peuvent endommager l'équipement et générer des circuits électriques. Des dégâts d'ESD surviennent lorsque des composants électroniques sont mal manipulés et peuvent causer des pannes totales ou intermittentes. Suivez les procédures de prévention d'ESD lors du retrait et du remplacement de composants.
- Portez un bracelet anti-ESD et veillez à ce qu'il soit bien au contact de la peau. Si aucun bracelet n'est disponible, reliez votre corps à la terre en touchant la partie métallique du châssis. Vérifiez régulièrement la valeur de résistance du bracelet antistatique, qui doit être comprise entre 1 et 10 mégohms (Mohms).

### **Consignes de sécurité électrique**

- Avant d'allumer l'appareil, reliez le câble de mise à la terre de l'équipement à la terre.
- Une bonne mise à la terre (connexion à la terre) est très importante pour protéger l'équipement contre les effets néfastes du bruit externe et réduire les risques d'électrocution en cas de foudre.
- Pour désinstaller l'équipement, débranchez le câble de mise à la terre après avoir éteint l'appareil.
- Un câble de mise à la terre est requis et la zone reliant les sections du conducteur doit faire plus de 4 mm<sup>2</sup> ou 10 AWG.

### **Procédure de mise à la terre pour source d'alimentation**

## CC Procédure de mise à la terre pour source

### d'alimentation CC

- Desserrez la vis du terminal de mise a la terre.
- Branchez le cable de mise a la terre a la terre.
- L'appareil de protection pour la source d'alimentation

CC doit fournir 30 A de courant. Cet appareil de protection doit etre branche a la source d'alimentation avant l'alimentation CC.

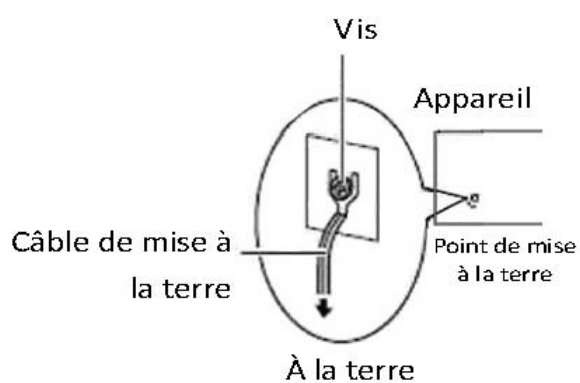

# Industrial Communication Platform

## Table of Contents

Revision History .....	2
Chapter 1: Introduction .....	9
Specifications .....	9
Ordering Information .....	11
Chapter 2: System Overview .....	12
Mechanical Drawing .....	12
Block Diagram .....	14
Front I/Os .....	15
Rear I/Os .....	17
Chapter 3: Board Layout.....	18
Jumpers & Connectors Locations on the Motherboard .....	18
Jumpers & Connectors Locations on the Add-on Card .....	19
Jumpers and Connectors Table .....	20
Jumper Settings & Connector Pinout.....	21
Chapter 4: Hardware Setup.....	29
Installing SO-DIMM Memory .....	30
Installing a Disk Drive .....	31
Mounting LEC-3030 by DIN Rail .....	32
Appendix 1: Watchdog Timer .....	33



# Chapter 1: Introduction

Thank you for choosing LEC-3030 series. This industrial computing system is powered by Intel Celeron N2807 or Intel Atom E3815 CPU with heat-sink thermal solution. Memory wise, the system supports up to 4GB DDR3L SDRAM SO-DIMM socket. Regarding I/O configurations, LEC-3030 provides 2 GbE LAN ports, and 2 USB ports. Regarding connections with industrial instruments, LEC-3030 supports 2 serial COM ports supporting RS-232, RS-422 or RS-485 through terminal block. For storage expansion, LEC-3030 series supports one SATA 2.5” HDD/SSD kit. To be deployed in commercial solar PV monitoring and other industrial applications, LEC-3030 supports wide temperature and has been certified by various safety and environmental regulation standards including classes of RoHS, CE, UL, FCC, EN61000 and WEEE.

**Product Features:**

- Intel® Celeron N2807 (LEC-3030A) or Intel® Atom E3815 CPU (LEC-3030T)
- 1 x 4 GB DDR3L SDRAM SO-DIMM socket
- Ethernet: 2 x GbE LAN ports
- USB: 1 x USB 2.0 Type-A port and 1 x USB 3.0 Type-A port
- Serial: 2 x RS-232/422/485 ports
- Digital I/O: 4 x DI and 4 x DO
- Display: 1 x VGA port
- Storage: 1 x SATA 2.5” HDD/SSD kit
- Wide temperature: -20 to 70°C (LEC-3030A) and -40 to 70°C (LEC-3030T)
- Standards & Certifications: RoHS, UL, CE, FCC, EN61000, WEEE

Please refer to the following table for detailed specifications

## Specifications

<b>Processor</b>	LEC-3030A: Intel CELERON N2807 1.58 GHz LEC-3030T: Intel Atom E3815 1.46 GHz CPU Heat-sink fanless thermal solution
<b>Memory</b>	1xSO-DIMM socket to support up to 4GB DDR3L SDRAM
<b>BIOS</b>	AMI SPI Flash BIOS
<b>OS</b>	Linux(Ubuntu), Windows XP Embedded, Window 7 Embedded, Window 7
<b>Serial</b>	2 x RS-232/422/485 ports via the terminal block

## Industrial Communication Platform

		ESD/surge/isolation protection (2KV by default)
		Serial Communication Parameters: <ul style="list-style-type: none"> <li>● Data bits: 5, 6, 7, 8</li> <li>● Stop bits: 1, 1, 5, 2</li> <li>● Parity: None, Even, Odd, Space, Mark</li> <li>● Flow control: RTS/CTS, XON/XOFF</li> <li>● Baud rate: up to 115200 bps</li> </ul>
<b>USB</b>		1 x USB 3.0 Type-A port 1 x USB 2.0 Type-A port (All support USB 5V protection)
<b>Display</b>		Intel® HD Graphics 1 x VGA
<b>Storage</b>		1x SATA 2.5" HDD/SSD kit
<b>Network</b>	Ethernet Controller	Intel® i210-IT
	Ethernet Ports	2 x GbE LAN ports with 1.5KV magnetic protection (1.5KV by default)
<b>DIO</b>	Connector	1x 2x5-pin Phoenix Contact Terminal Block connector for 4x DI/DO w/ isolation
	DI	Wet contact (0:0~+3Vdc Max; 1:+5Vdc TTL type) ESD protection for 15KV
	DO	Open collect to 5Vdc, 50mA max load
<b>LEDs</b>		1 x PWR/HDD LED set for power and storage status. RX/TX LED set for Serial COM ports ACT/LINK LED set for LAN ports
<b>Physical Characteristics</b>	Dimensions	LEC-3030A: 130.0 x 52.0 x 127.0, unit: mm LEC-3030T: 130.0 x 57.5 x 127.0, unit: mm
	Housing	Steel, Aluminum
	Mounting	DIN Rail, Wall-mounting
<b>Power</b>	Input Voltage	12~36Vdc power input w/ 2xpin Phoenix Contact connector Ground contact
<b>Reliability Tool</b>	Automatic Reboot Setting	Watchdog Timer 1~255 level time interval system reset, software programmable
	Alter Tool	Built-in buzzer and RTC (real-time clock) with lithium battery backup
<b>Environment</b>	Operating	LEC-3030A: -20~70°C

## Industrial Communication Platform

	Temperature	LEC-3030T: -40~70°C
	Non-operating Temperature	-40~85°C
	Humidity	5 to 95% (non-condensing)
	Vibration	-IEC 60068-2-64 (Random 1 Oct./min, 1hr/axis.) -With HDD: 1 Grms @ 5 ~ 500 Hz
	Shock	-IEC 60068-2-27: 20 G half sine, 11 ms
<b>Standards &amp; Regulations</b>	Green	RoHS, WEEE
	Safety	UL/cUL (UL 60950-1, CSA C22.2 No. 60950-1-03), LVD (EN60950-1), BIS
	EMC	CE (EN 55022, EN 61000-3-2, EN 61000-3-3, EN 55024), FCC(Part 15 Subpart B, CISPR 22 Class ), CCC (GB9254, GB 17625.1)

## Ordering Information

<b>LEC-3030A</b>	Intel® Celeron N2807, 1+1 GbE, 1xUSB3, 1xUSB2, 2xisolated RS-232/422/485, 4xDI/O, VGA(pin header) for -20~70°C
<b>LEC-3030T</b>	Intel® Atom E3815, 1+1 GbE, 1xUSB3, 1xUSB2, 2xisolated RS-232/422/485, 4xDI/O, VGA(pin header) for -40~70°C

# Chapter 2: System Overview

## Mechanical Drawing

LEC-3030A

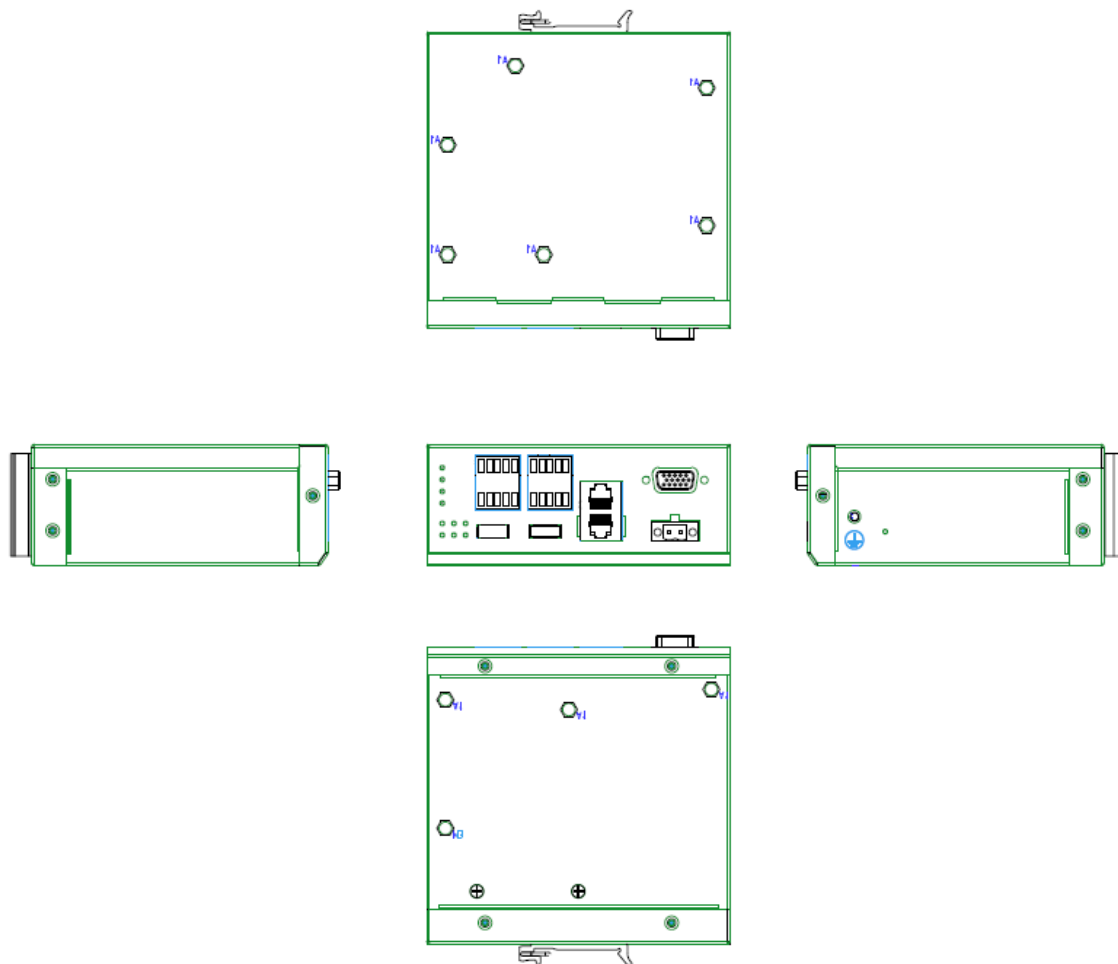

Unit: mm

# Industrial Communication Platform

LEC-3030T

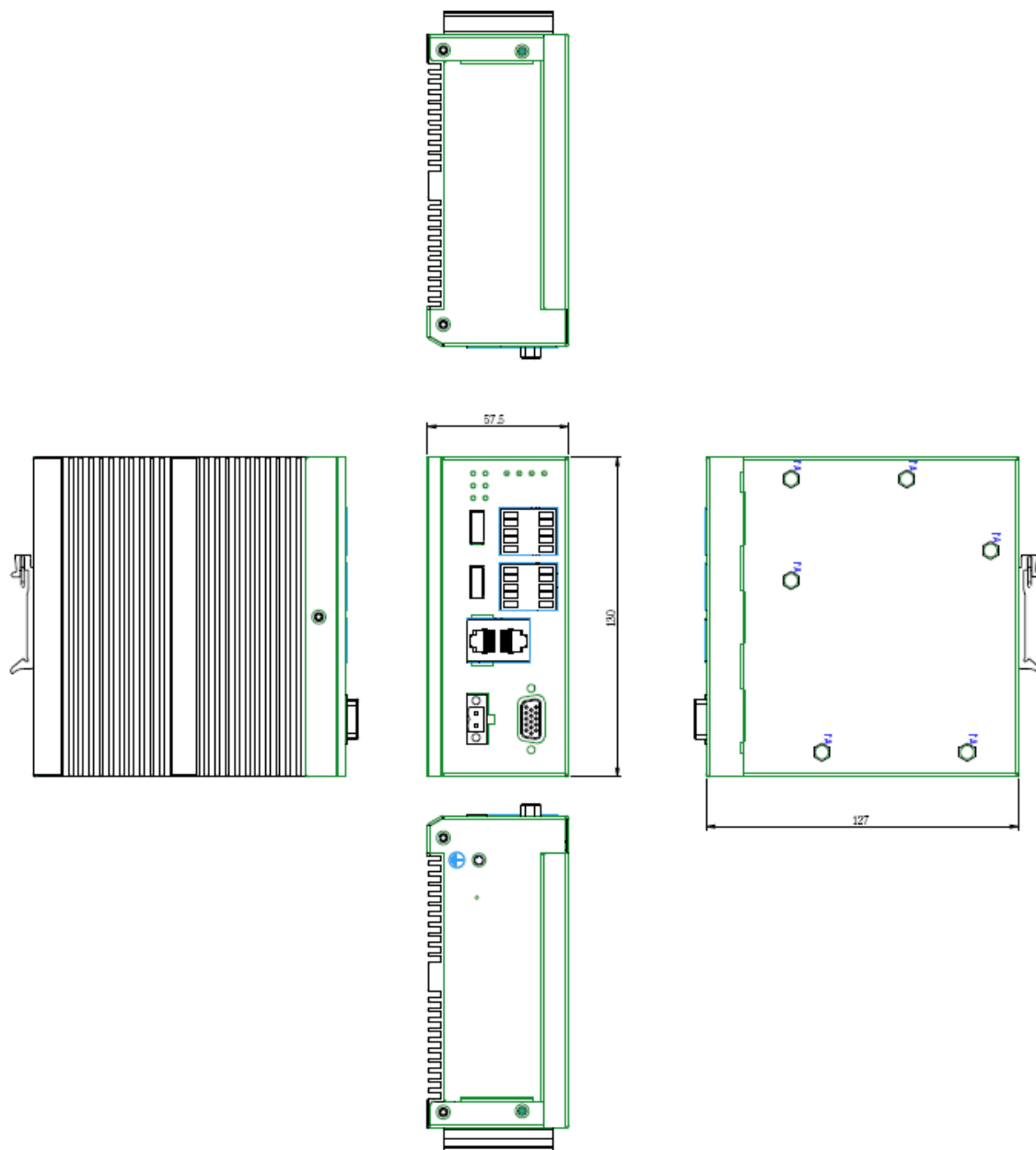

Unit: mm

# Industrial Communication Platform

## Block Diagram

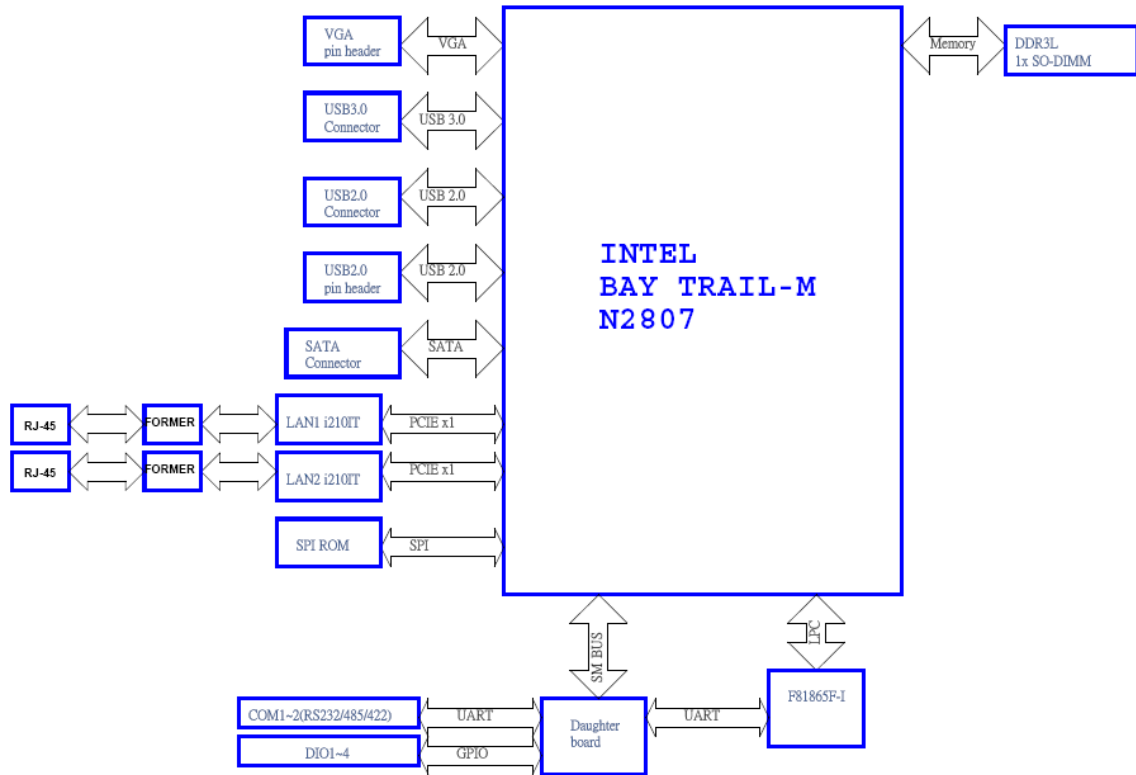

Notes: the daughter board refers to the add-on cards based on the model variations.

## Front I/Os

LEC-3030A

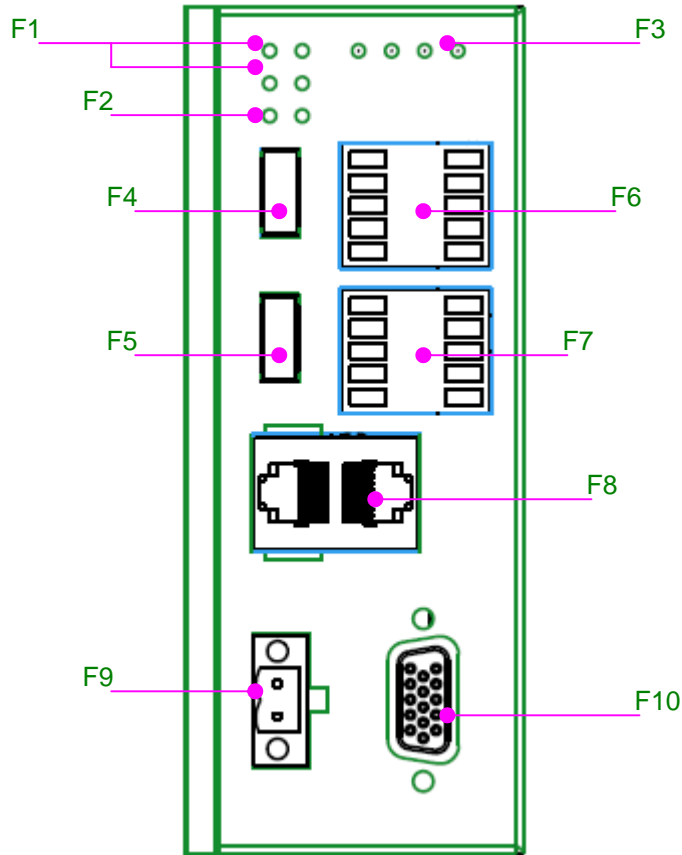

F1 LAN1/2 LED	LED set indicating ACT/LINK status for LAN1 and LAN2
F3 PWR/HDD LED	1 x PWR/HDD LED set for power and storage activity status
F3 TX/RX LED	2 x TX/RX LED pairs indicating status of 2 Serial COM ports
F4 USB 3.0	1 x USB3.0 Type-A port
F5 USB 2.0	1 x USB2.0 Type-A port
F6 Terminal Block (Serial COM)	2 x 5-pin terminal block for 2 x RS-232/422/485 ports
F7 DIO	2 x 5-pin terminal block for Digital Input/Output
F8 LAN	2 x GbE LAN ports
F9 DC IN	12~36Vdc power input w/ 2xpin Phoenix Contact connector
F10 VGA	1 x VGA display port

## Industrial Communication Platform

### LEC-3030T

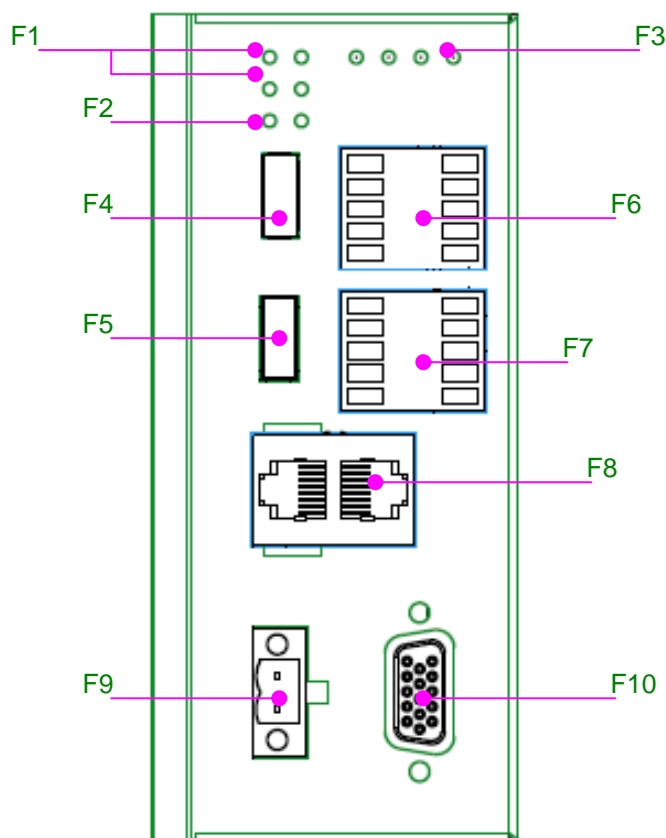

<b>F1</b> LAN1/2 LED	LED set indicating ACT/LINK status for LAN1 and LAN2
<b>F3</b> PWR/HDD LED	1 x PWR/HDD LED set for power and storage activity status
<b>F3</b> TX/RX LED	2 x TX/RX LED pairs indicating status of 2 Serial COM ports
<b>F4</b> USB 3.0	1 x USB3.0 Type-A port
<b>F5</b> USB 2.0	1 x USB2.0 Type-A port
<b>F6</b> Terminal Block (Serial COM)	2 x 5-pin terminal block for 2 x RS-232/422/485 ports
<b>F7</b> DIO	2 x 5-pin terminal block for Digital Input/Output
<b>F8</b> LAN	2 x GbE LAN ports
<b>F9</b> DC IN	12~36Vdc power input w/ 2xpin Phoenix Contact connector
<b>F10</b> VGA	1 x VGA display port



## Rear I/Os

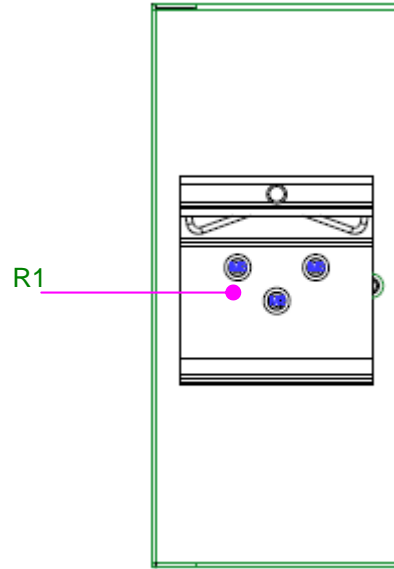

R1 DIN Rail

DIN Rail mounting bracket

# Chapter 3: Board Layout

## Jumpers & Connectors Locations on the Motherboard

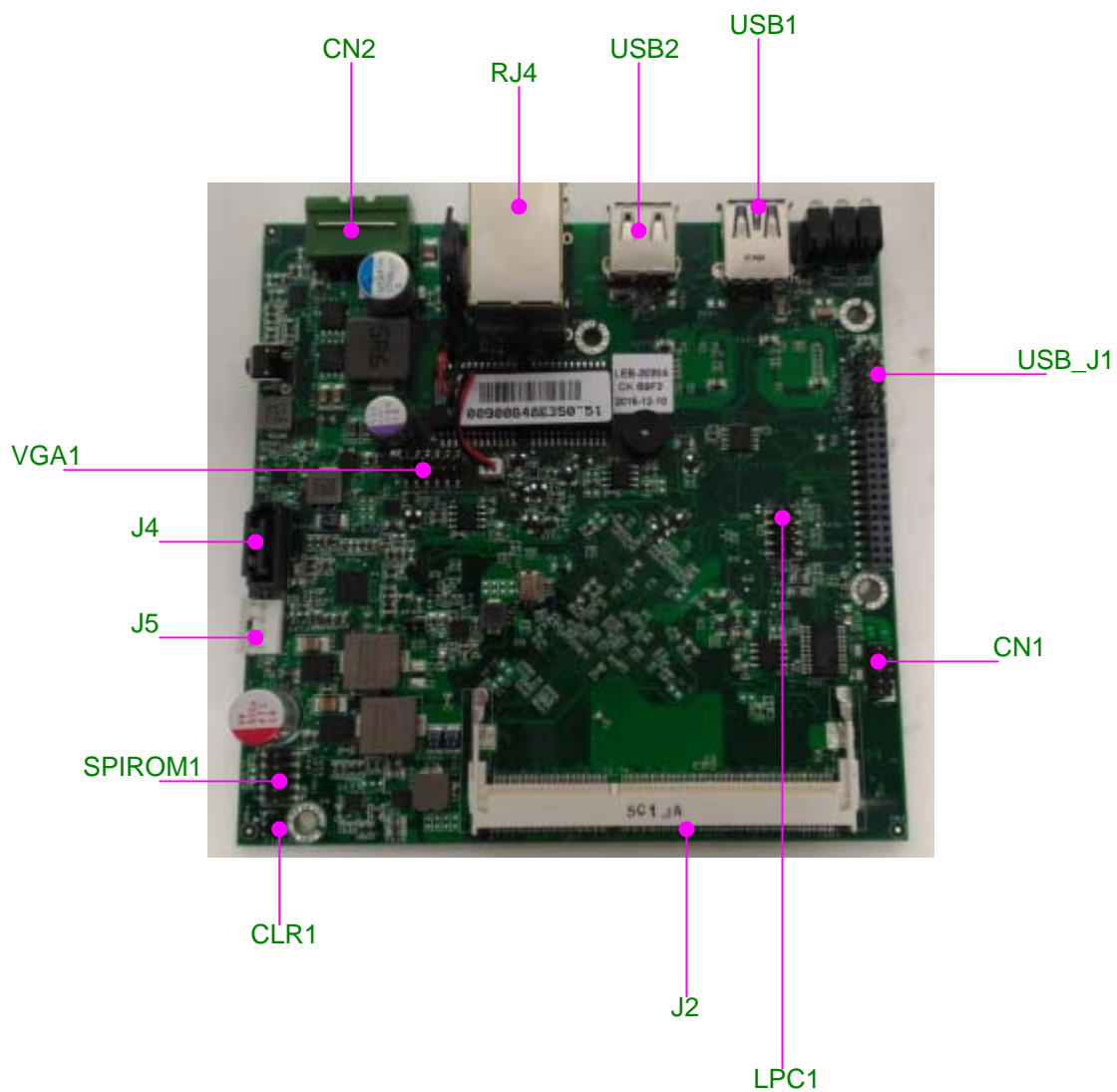

## Industrial Communication Platform

### Jumpers & Connectors Locations on the Add-on Card

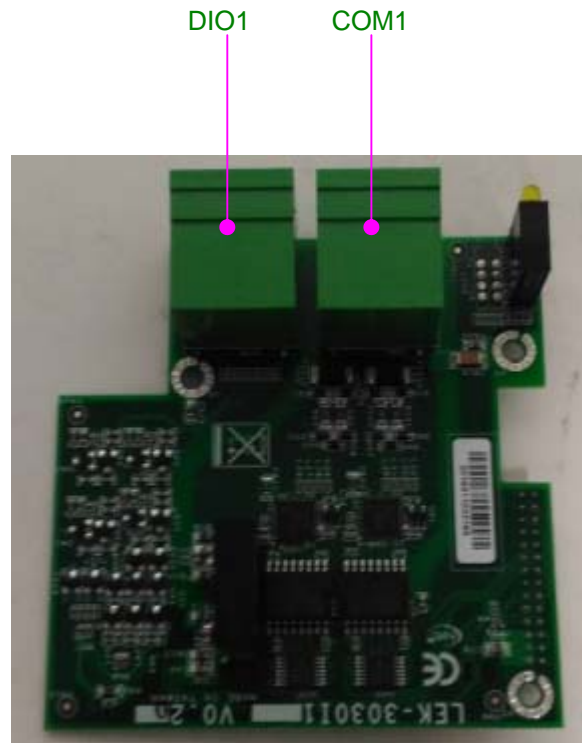

### Jumpers and Connectors Table

#### The Motherboard

Label	Description	Note
RJ4	Double-stacked GbE LAN ports	
USB2	1 x USB 2.0 Type-A port	
USB1	1 x USB 3.0 Type-A port	
VGA1	1 x VGA internal pin header	
CN2	DC Power input	
CLR	Clear CMOS jumper	
J2	SO-DIMM socket	
LPC1	Low-Pin-Count for debug use only	
SPIROM1	Debug use only	
J4	SATA 7-pin signal connector	
J5	SATA 4-pin power connector	
USB_J1	Internal USB2.0 pin header	
CN1	COM internal pin header	
DIMM	SO-DIMM socket	
COM1	2-5pin terminal block for serial COM signals	
DIO1	2-5pin terminal block for DIO	

## Jumper Settings & Connector Pinout

### Jumper Setting

#### CLR1: Clear CMOS

Jumper	Description
1-2 (Default)	Normal
2-3	Clear CMOS



#### PWR1: Power Button

Jumper	DESCRIPTION
1-2	Power ON/OFF system
NC (Default)	Normal



### Connector Pin Assignment

**VGA1:** internal VGA pin header, which enables the VGA port when connected with a VGA ribbon cable.

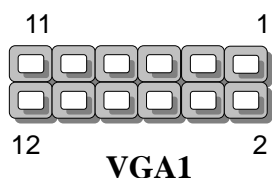

Pin	Description
1	Red Color Signal
2	Ground
3	Green Color Signal
4	Ground
5	Blue Color Signal
6	Ground
7	H-Sync
8	Ground
9	V-Sync

## Industrial Communication Platform

10	Ground
11	DDC-DATA
12	DDC-CLK

### CN1: COM Console internal pin header

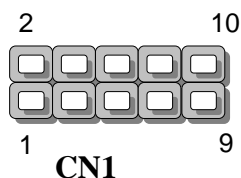

Pin number	Pin signal
1	DCD
2	DSR
3	RXD
4	RTS
5	TXD
6	CTS
7	DTR
8	RI
9	GND
10	5V

### USB1: USB3.0 Type-A port

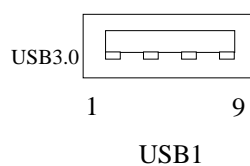

Pin	Description
1	USB power
2	USB4N
3	USB4P
4	GND
5	USB3.0_RXN
6	USB3.0_RXP
7	GND
8	USB3.0_TXN
9	USB3.0_TXP

### USB2: USB2.0 Connector

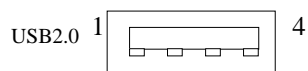

Pin	Description
1	USB power
2	USB3N
3	USB3P
4	GND

### USB\_J1: USB2.0 internal pin header

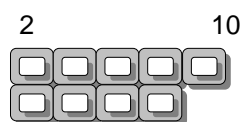

Pin	Description
1	USB power
2	USB power
3	USB0N
4	USB1N
5	USB0P
6	USB1P
7	GND
8	GND
9	NC
10	NC

### RJ4: LAN1 and LAN2 Ethernet GbE ports in double-stacked form

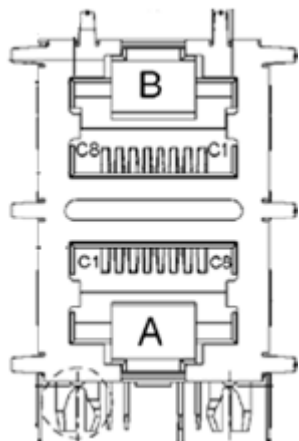

## Industrial Communication Platform

Pin	Description	Pin	Description
A1	P1_MDXP0	B1	P2_MDXP0
A2	P1_MDYN0	B2	P2_MDYN0
A3	P1_MDXP1	B3	P2_MDXP1
A4	P1_MDYN1	B4	P2_MDYN1
A5	P1_MDXP2	B5	P2_MDXP2
A6	P1_MDYN2	B6	P2_MDYN2
A7	P1_MDXP3	B7	P2_MDXP3
A8	P1_MDYN3	B8	P2_MDYN3
PAD1	GND	PAD4	GND
PAD2	GND	PAD5	GND
PAD3	GND	PAD6	GND
ALED1	P1_LINK_100_N	BLED1	P2_LINK_100_N
ALED2	P1_LINK_1000_N	BLED2	P2_LINK_1000_N
ALED3	VCC3	BLED3	VCC3
ALED4	P1_ACTIVE_N	BLED4	P2_ACTIVE_N

### J5: SATA Power Connector

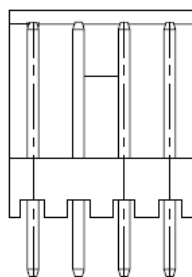

Pin	Description
1	12V
2	GND
3	GND
4	VCC5

### J4: SATA Connector





## Industrial Communication Platform

Pin	Description	Pin	Description
1	GND	5	SATA_RX1_DN
2	SATA_TX1_C_DP	6	SATA_RX1_DP
3	SATA_TX1_C_DN	7	GND
4	GND		

### CN2: DC Power input connector

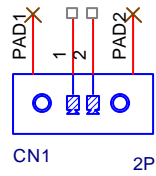

Pin	Description
1	GND
2	POWER

### SPIROM1: SPI ROM Connector (For debug use)

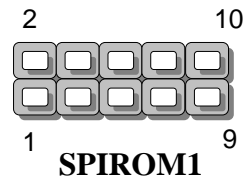

Pin	Description	Pin	Description
1	SPI_HOLD_N	2	SPI_CS1_R_N
3	SPI_CS0_R_N	4	V_3P3_SPI_R
5	SPI_MISO_R	6	SPI_HD0_N
7	NC	8	SPI_CLK
9	GND	10	SPI_MOSI_R

### LPC1: LPC Connector (For debug use)

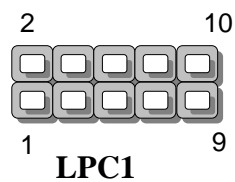

## Industrial Communication Platform

Pin	Description	Pin	Description
1	LPC_CLK_1	2	LPC_AD1
3	PLTRST_P80_N	4	LPC_AD0
5	LPC_FRAME_N	6	P3V3
7	LPC_AD3	8	GND
9	LPC_AD2	10	GND

### J3: COM port card pin header (For COM/DIO card)

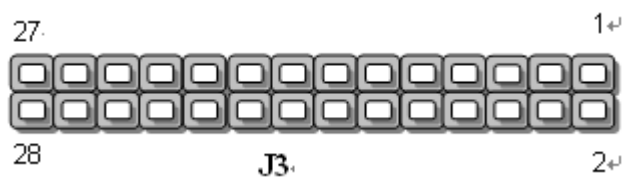

Pin	Description
1	P3V3
2	P5V
3	P3V3
4	P5V
5	P3V3
6	P5V
7	COM3_RTS#
8	COM4_RTS#
9	COM3_TXD
10	COM4_TXD
11	COM3_RXD
12	COM4_RXD
13	GND
14	GND
15	COM1_RTS#
16	COM2_RTS#
17	COM1_TXD
18	COM2_TXD
19	COM1_RXD
20	COM2_RXD
21	GND
22	GND

## Industrial Communication Platform

23	SMB_SOC_DATA_3P3
24	GND
25	SMB_SOC_CLK_3P3
26	GND
27	GND
28	GND

### COM1: COM 2 and COM 3 ports through the 2-pin terminal block

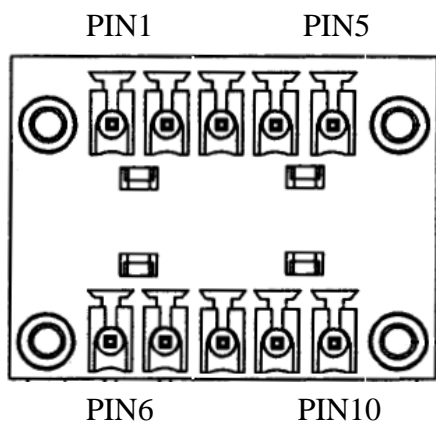

PIN	1	2	3	4	5
RS-232			SIN	SOUT	GND
RS-422	TX+	TX-	RX-	RX+	GND
RS-485	D+	D-			GND
PIN	6	7	8	9	10
RS-232			SIN	SOUT	GND
RS-422	TX+	TX-	RX-	RX+	GND
RS-485	D+	D-			GND

### DIO1: DI1~4,DO1~4

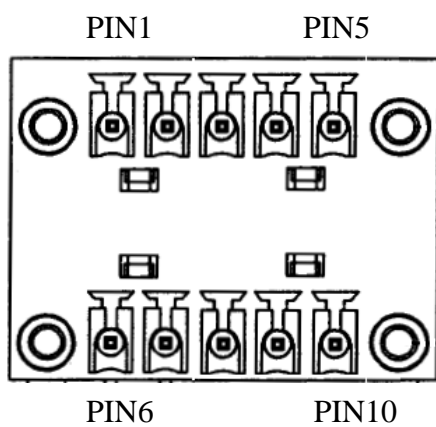

## Industrial Communication Platform

<b>PIN</b>	<b>1</b>	<b>2</b>	<b>3</b>	<b>4</b>	<b>5</b>
	DI0	DI1	DI2	DI3	GND
<b>PIN</b>	<b>6</b>	<b>7</b>	<b>8</b>	<b>9</b>	<b>10</b>
	DO0	DO1	DO2	DO3	GND

## Chapter 4: Hardware Setup

### Preparing the Hardware Installation

To access some components and perform certain service procedures, you must perform the following procedures first.

**WARNING:**

- To reduce the risk of personal injury, electric shock, or damage to the equipment, please remove all power sources.
- Please wear ESD protected gloves before conducting the following steps.
- Do NOT pile items on top of the system to prevent damages due to this improper use. Lanner is not liable for damages caused by improper use of the product.

1. Power off LEC-3030 and remove the power cord.
2. Remove the screws from the sides and the rear, as circled in the image below.



## Industrial Communication Platform

You may have to remove the 3 screws on the DIN Rail mount bracket in order to remove the required circled screw.



## Installing SO-DIMM Memory

The system is designed with a SO-DIMM socket supporting up to 4GB DDR3L SDRAM. Please follow the steps below for proper installations.

1. Locate the SO-DIMM socket on the motherboard.
2. Align the memory module's key with the SO-DIMM socket's key.
3. Insert the SO-DIMM module.
4. Press the module down until it is locked by the two clips at each side.

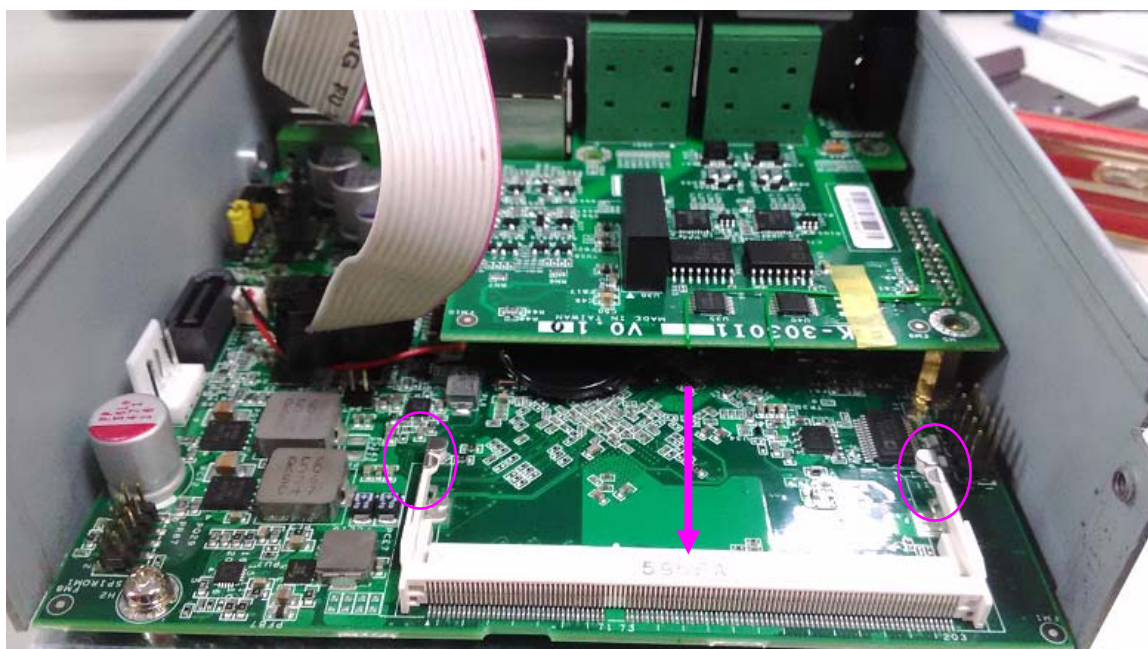

## Installing a Disk Drive

The system can accommodate one 2.5" SATA disk drive. Please follow the steps below.

1. LEC-3030 provides the space for one SATA 2.5" HDD/SSD tray on the inner side of the compartment. Please install the supplied HDD/SSD installation kit first.



2. Place the disk drive in the tray.
3. Apply two screws on each side.
4. Connect the supplied SATA cable to the disk drive as shown in the image below.
5. Connect the 7-pin signal connector and the 4-pin power connector to the corresponding ports on the motherboard.

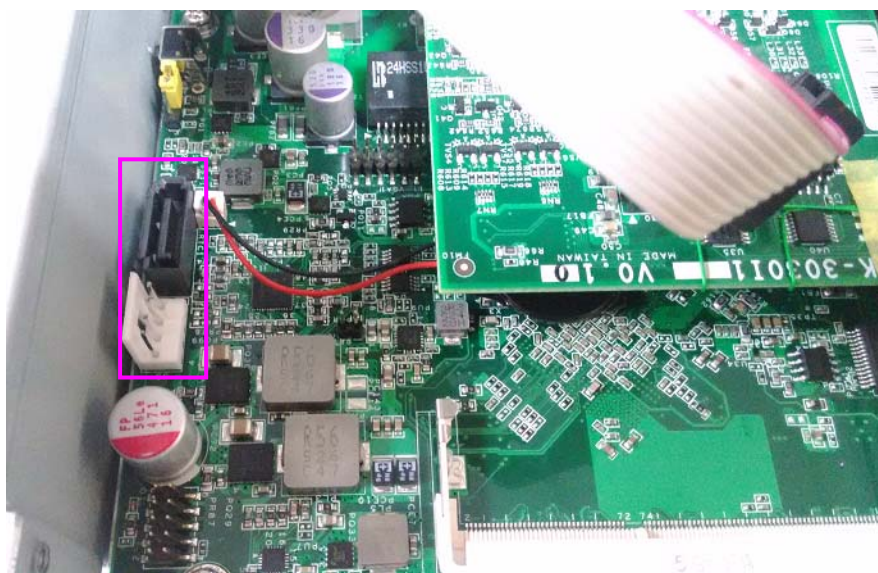



## **Mounting LEC-3030 by DIN Rail**

All models of the LEC-3030 series are designed with a DIN Rail mounting bracket at the rear of the product.

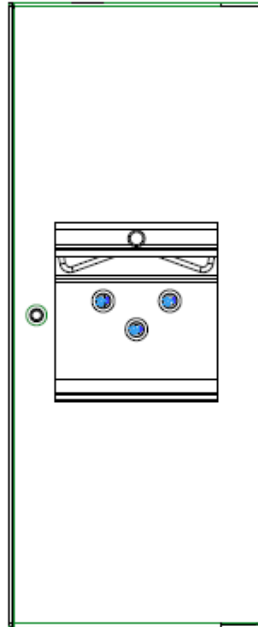

Hang the device onto a rail until it firmly attaches.





## Appendix 1: Watchdog Timer

A watchdog timer is a piece of hardware that can be used to automatically detect system anomalies and reset the processor in case there are any problems. Generally speaking, a watchdog timer is based on a counter that counts down from an initial value to zero. The software selects the counter's initial value and periodically restarts it. Should the counter reach zero before the software restarts it, the software is presumed to be malfunctioning and the processor's reset signal is asserted. Thus, the processor will be restarted as if a human operator had cycled the power.

For sample watchdog code, see *watchdog* folder on the *Driver and Manual CD*

